



# PTU-52/5200/4200 Series

Frequency-Hopping

Dual / Quad / Eight-Channel Wireless Microphone System



## USER MANUAL

# IMPORTANT SAFETY INSTRUCTIONS

1. Read and follow these instructions carefully.
2. Only use attachments, accessories, and spare parts specified by the manufacturer.
3. Avoid exposing the product and its connections to liquids and electrically conductive objects that are not essential for its operation.
4. Do not operate near any heat sources, such as open flames, radiators, or other apparatus that produce heat.
5. Keep the power cord safe by preventing it from being walked on or pinched, especially at the plugs.
6. Do not use the apparatus during lightning storms, and unplug it when unused for a long period of time.
7. Any modifications not approved by the manufacturer for the product could result in personal injury or product failure.
8. Operate this product within its proper operating temperature range.



Caution: This symbol indicates the unit might have a risk of electric shock.



Caution: This symbol is used to alert you to potential personal injury hazards. Obey all safety messages with this symbol to avoid possible injury or death.



Caution: This symbol indicates possible risk of electric shock within the unit.



Caution: This symbol means the product must not be discarded as household waste, and should be delivered to an appropriate collection facility for recycling. Proper disposal and recycling helps protect natural resources, human health and environment. For more information on disposal and recycling of this product, contact your local municipality, disposal service, or shop where you bought this product.

## IMPORTANT PRODUCT INFORMATION

Licensing: A ministerial license may be required to operate this equipment in certain areas. Consult your national authority for possible requirements. Changes or modifications not expressly approved by the manufacturer responsible for compliance could void the user's authority to operate the equipment. Licensing of PHENYX PRO wireless microphone equipment is the user's responsibility, and licensability depends on the user's classification and application, and on the selected frequency. PHENYX PRO strongly urges the user to contact the appropriate telecommunications authority concerning proper licensing, and before choosing and ordering frequencies.

## FCC Information

This device complies with part 15 of the FCC rules. Operation is subject to the following two conditions:

- (1) This device may not cause harmful interference, and
- (2) This device must accept any interference received, including interference that may cause undesired operation.

\*NOTE: This equipment has been tested and found to comply with the limits for a Class B digital device, pursuant to Part 15 of the FCC Rules. These limits are designed to provide reasonable protection against harmful interference in a residential installation. This equipment does not cause harmful interference to radio or television reception, which can be determined by turning the equipment off and on, the user is encouraged to try to correct the interference by one or more of the following measures:

- Reorient or relocate the receiving antenna.
- Increase the separation between the equipment and receiver.
- Connect the equipment into an outlet on a circuit different from that to which the receiver is connected.
- Consult the dealer or an experienced radio/TV technician for help

This equipment complies with FCC radiation exposure limits set forth for an uncontrolled environment. This equipment should be installed and operated with minimum distance 20 cm between the radiator & your body.

## IC Statement

This device contains license-exempt transmitter(s)/ receiver(s) that comply with Innovation, Science and Economic Development Canada's licence-exempt RSS(s). Operation is subject to the following two conditions:

- (1) This device may not cause interference, and
- (2) This device must accept any interference, including interference that may cause undesired operation of the device.

The term "IC" before the certification/registration number only signifies that the Industry Canada technical specifications were met. This product meets the applicable Industry Canada technical specifications.

Cet appareil contient des émetteurs/récepteurs exemptés de licence conformes aux RSS (RSS) d'Innovation, Sciences et Développement économique Canada. L'exploitation est autorisée aux deux conditions suivantes :

- (1) l'appareil ne doit pas produire de brouillage, et
- (2) l'utilisateur de l'appareil doit accepter tout brouillage radioélectrique subi, même si le brouillage est susceptible d'en compromettre le fonctionnement.

This equipment complies with ISED radiation exposure limits set forth for an uncontrolled environment. This equipment should be installed and operated with minimum distance 20 cm between the radiator & your body

Cet équipement est conforme aux limites d'exposition aux rayonnements ISED établies pour un environnement non contrôlé.

Cet équipement doit être installé et utilisé avec une distance minimale de 20 cm entre le radiateur et votre corps

**Industry Canada ICES-003 Compliance  
Label: CAN ICES-3 (B)/NMB-3(B)**

---

## EU Directives

 This product meets the Essential Requirement of all relevant European directives and is eligible for CE marking.

Meets essential requirements of the following European Directives:

WEEE Directive 2019/19/EU

RoHS Directive EU 2015/863

Note: Please follow your regional recycling scheme for batteries and electronic waste

## Authorized European Representative



**APEX CE SPECIALISTS LIMITED**  
6F East Union Street, Manchester, England, M16 9AE  
United Kingdom  
Email: info@apex-ce.com



**APEX CE SPECIALISTS GmbH**  
Grafenberger Allee 277, 40237 Düsseldorf, Germany  
Email: info@apex-ce.com

*Thank you for purchasing the Phenyx Pro PTU-52/5200/4200 Series UHF Wireless Microphone System. For the best results and utmost satisfaction with your new unit, please read this manual carefully to ensure proper operation, and keep it for future reference. For more information, please visit our store: [www.phenyxpro.com](http://www.phenyxpro.com)*

## **Table of Contents**

---

<b>System Description</b> .....	<b>6</b>
System overview.....	6
System features.....	6
System components.....	7
<b>Operating Instructions</b> .....	<b>8</b>
Set up.....	8
Operation tips.....	10
<b>Functions of Parts</b> .....	<b>11</b>
Receiver.....	11
Transmitters.....	13
<b>Troubleshooting Tips</b> .....	<b>15</b>
<b>Specifications</b> .....	<b>16</b>
<b>Technical Support &amp; Warranty Information</b> .....	<b>17</b>

# System Description

## System overview

The Phenyx Pro PTU-52/5200/4200 Series represents a significant step towards offering the convenience and sound quality every performer aspires to. It merges high-quality sound, straightforward setup, and an intuitive interface for outstanding audio performance straight out of the box. The microphone capsule employs cardioid polar pattern that effectively captures and transmits sound and eliminates feedback and ambient noise. These systems feature multiple selectable frequency sets, providing enhanced flexibility and interference-free operation. Boasting an operating range of up to 200 feet in open spaces, this series is ideal for public speaking, conference meetings, singing, churches, and outdoor events.

## System features

- 1 - Built to last, our metal UHF cordless microphone receiver and handheld microphones withstand heavy use.
- 2 - Employs a high-quality cardioid capsule to ensure sound is captured and transmitted clearly without dropouts or feedback.
- 3 - Each handheld microphone is equipped with an anti-rolling ring for enhanced protection.
- 4 - Features state-of-the-art circuitry with multiple adjustable frequency sets (2x30 for PTU-52, 4x25 for PTU-5200, 8x20 for PTU-4200) in the 500MHz band.
- 5 - Offers the flexibility to change frequencies seamlessly if any preset frequency encounters issues.
- 6 - Boasts an operational distance of up to 200ft in line-of-sight open spaces.
- 7 - Delivers robust, clean, and stable sound quality ideal for various events such as church services, weddings, public speaking, teaching, conferences, and outdoor occasions.

## System components

Your system comes with a combination of the following components.

### Receiver

PWR-52	2-Channel Wireless Receiver
PWR-5200	4-Channel Wireless Receiver
PWR-4200	8-Channel Wireless Receiver

### Transmitters

PWH-4200	Handheld Transmitter
PWB-4200	Bodypack Transmitter

### Accessories

1HM1LM-BLK	Black Headset & Lapel Mic Combo
ANTB-500	Antenna for 500 UHF Band
PTA-ADP1	Power Adapter
PTA-CBL	1/4" Audio Cable
	6.45MM to 3.5MM Adapter
	User Manual
	AA Battery
	Rubber Feet
	Anti-rolling Ring
	Short Rackmount Bracket

**\*Caution:** Risk of explosion if battery replaced by an incorrect type, Dispose of used batterie according to the instructions.

# Operation Instructions

## Set up

### Step 1: Connect the receiver

- ① Plug the power adapter into the receiver and connect it to a power source.
- ② Secure the antennas to the receiver, arranging them 60 degrees apart for optimal signal reception.
- ③ Connect the audio outputs (either the 1/4" mixed output or XLR output) from the system to an amplifier, speaker, mixer, etc.

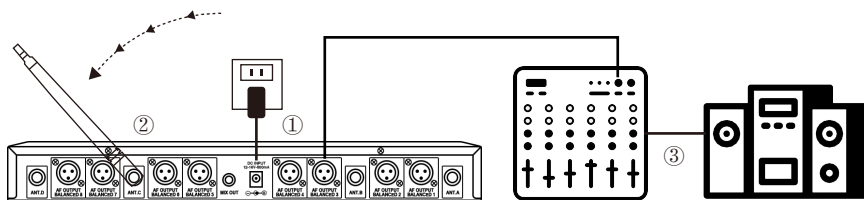

### Step 2: Turn on transmitters

- ① Install fresh batteries in the transmitters (refer to the section relative to the specific transmitter you are using).
- ② Press power buttons to turn on transmitters

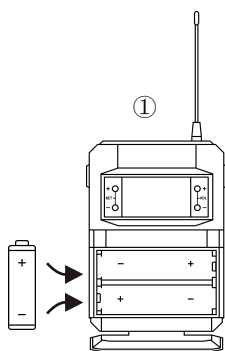

Turn on the bodypack transmitter

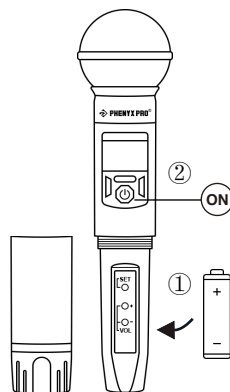
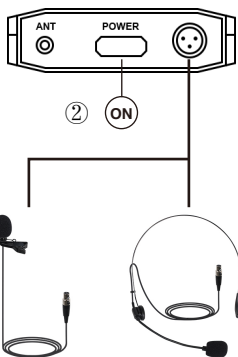

Turn on the handheld transmitter

**Step 3: Pair up the receiver and transmitters**

- ① Ensure the volume of your speakers is off, turn on the receiver and the transmitters. The LCD display turns on and the "MUTE" disappears, indicating that the corresponding transmitter is paired with the receiver. The AF signal indicates the presence of an audio signal coming from the transmitter.
- ② Open the transmitter battery compartment and press the SET button to adjust the frequency. The transmitter will pair up with the receiver automatically and the LCD display on the receiver will change accordingly. Please aim the microphone transmitter to the receiver and the distance between them should not be more than 10ft away.
- ③ Turn your speaker's volume back on and gradually increase the volume until the desired level is reached.



"MUTE" Disappears/AF Signal Appears

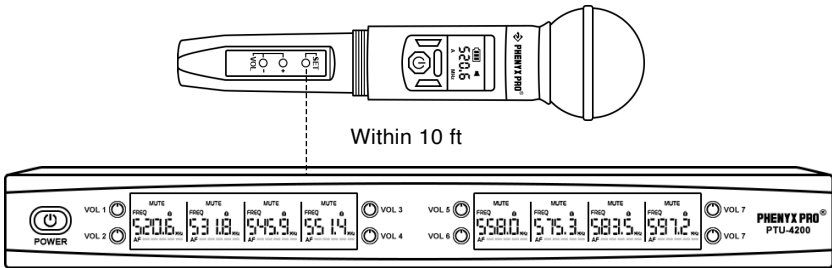

## Operation tips

### 1. Change Frequency

Short press the SET button to change the frequency. The MUTE symbol might be on during the process. Wait for one second and it will disappear.

### 2. Change the Microphone's Channel Group

Before setup, please turn off the transmitter that occupied the original channel to avoid interference. Press the power button to turn on the transmitter that you want to pair with the channel. Press the SET button for 3 seconds to switch the channel. The preset Channel A with the symbol "A 01" (meaning the transmitter is set to Channel A with frequency set 01) will be switched to Channel B/C/D/E/F/G/H as needed.

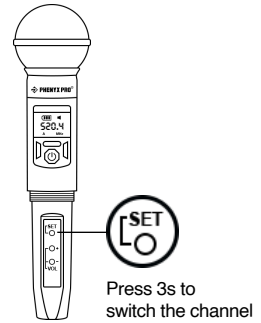

### 3. Lock the Microphone with a Specific Channel

When the microphone is switched to a new channel, it will not automatically connect. You need to lock the microphone with the new channel so that it will connect to the receiver. Turn off the microphone once you change the channel group by following the instructions above. Put the transmitter closer to the receiver. Then long press the SET and Power buttons together for 3 seconds and there will be "---" dash line symbols on the screen, which means the microphone is pairing with the receiver. Once the dash line disappears, it means the pairing process is completed. Check the receiver's channel display, and if the MUTE sign disappears, it means the pairing is successful and the system is ready to go.

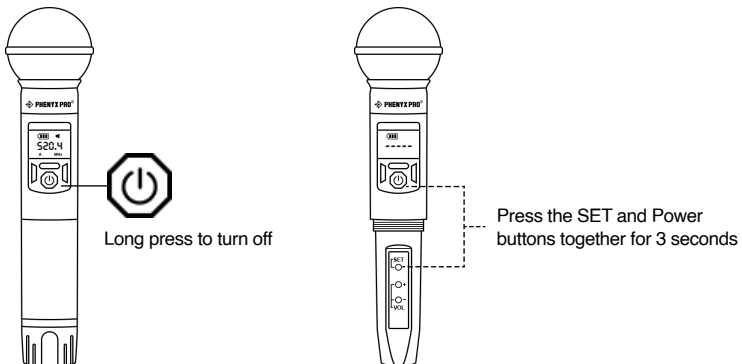

# Functions of Parts

## Receiver

### PWR-52

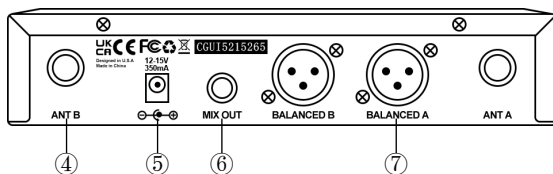
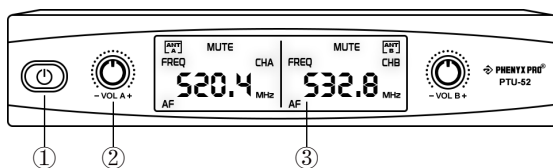

### PWR-5200

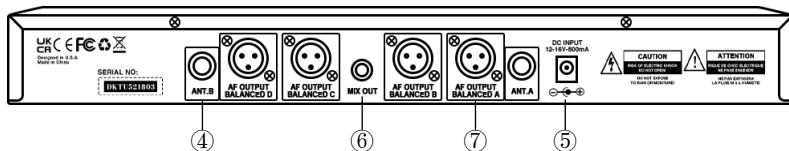
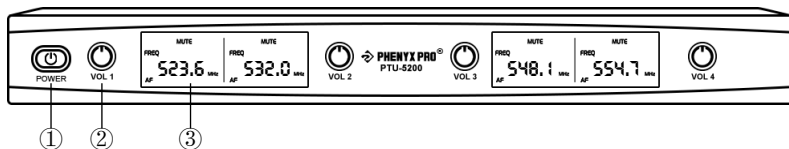

## PWR-4200

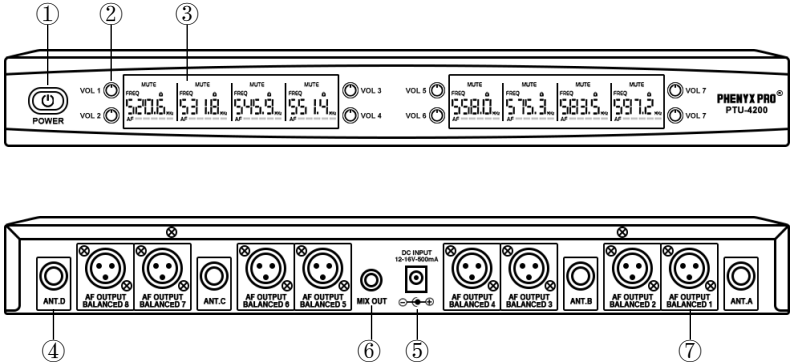

- ① **Power switch:** Press the button for 1 sec to turn on the receiver and press it again to turn it off.
- ② **Volume control:** Adjust the output sound volume of Channel A (each channel has its corresponding individual volume control).
- ③ **LCD display**
- ④ **Antenna jack**
- ⑤ **Power jack:** Connect AC/DC adapter to the receiver.
- ⑥ **1/4" Audio output jack:** Connect the audio cable from this jack to the input port of amplifier, mixer, or other PA system.
- ⑦ **XLR Audio output jack:** Balanced XLR output for CHA (each channel has its corresponding XLR output).

## Transmitters

### PWH-4200

#### Handheld transmitter

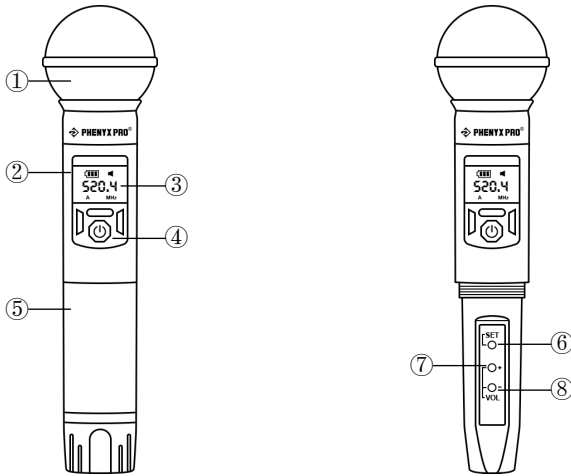

- ① **Microphone capsule**
- ② **LCD battery power display**
- ③ **LCD frequency display**
- ④ **ON/OFF/MUTE switch:** Long press this switch to turn on/off, tap to mute the microphone.
- ⑤ **Battery cover**
- ⑥ **SET button:** Press SET button to change frequency of the handheld mic
- ⑦ **Volume increase:** Press "+" to increase volume of the handheld mic
- ⑧ **Volume decrease:** Press "-" to decrease volume of the handheld mic

If the battery power icon indicates that the battery power is low, the batteries must be replaced to maintain normal operation. Unscrew battery cover and press SET button to change frequency of the handheld microphone. The receiver will automatically pair up with the handheld within seconds (pairing distance is less than 10ft).

## PWB-4200

### Bodypack transmitter

The Phenyx UHF bodypack is to be used with the Phenyx lavalier microphone & headsets.

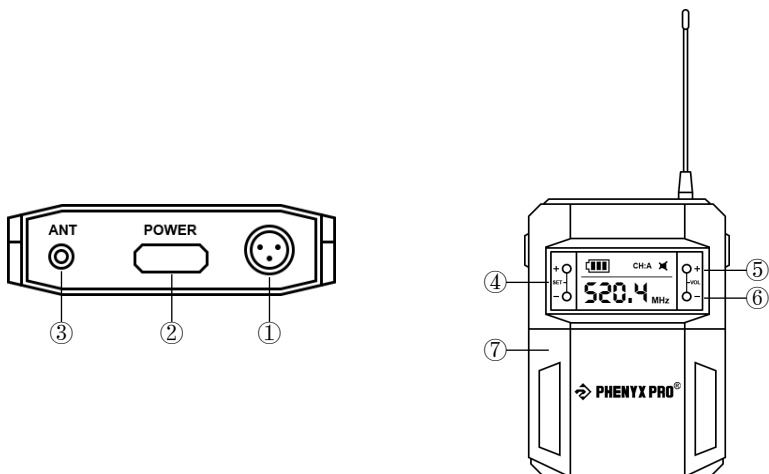

- ① **Microphone input**
- ② **Power button:** Long press this switch to turn on/off, tap to mute the microphone.
- ③ **Antenna**
- ④ **SET button:** Press the SET button to change the frequency of the bodypack.
- ⑤ **Volume increase:** Press "+" to increase the volume of the bodypack.
- ⑥ **Volume decrease:** Press "-" to decrease the volume of the bodypack.
- ⑦ **Battery compartment**

#### Set Up:

- 1 - Secure the bodypack to clothing, belt, or pocket.
- 2 - For a lavalier microphone, clip the microphone to clothing about 1 foot below the mouth. For a headset, install the headset comfortably on the head so the microphone can be placed close to the mouth.
- 3 - Connect the microphone audio connector to the bodypack microphone input ①.
- 4 - Turn the bodypack on by pressing the ON/OFF/MUTE button.

## Troubleshooting Tips

ISSUE	INDICATOR STATUS	CORRESPONDING SOLUTION
No sound or faint sound	Receiver LCD screen off	<ul style="list-style-type: none"> <li>• Make sure the DC adapter is securely plugged into an electrical outlet.</li> <li>• Make sure the receiver is powered on.</li> </ul>
	Receiver LCD screen on	<ul style="list-style-type: none"> <li>• Make sure the transmitter successfully transmits audio signals. You can see the AF indicator lighting on the receiver screen. Otherwise, replace the batteries for the transmitter. If it does not work, replace the transmitter.</li> <li>• Adjust the volume controls of the receiver and speaker to proper levels.</li> <li>• Make sure the receiver is connected to the turned-on speaker or the turned-on amplifier and speaker together to output sound.</li> </ul>
Low battery	The battery indicator shows low battery status	<ul style="list-style-type: none"> <li>• Replace fresh batteries for the transmitter.</li> </ul>
A howling noise (also "feedback") from the speaker		<ul style="list-style-type: none"> <li>• Do not point the microphone directly at the speaker. Increase their distance.</li> </ul>
Interference or poor signal quality		<ul style="list-style-type: none"> <li>• Change the frequency of the transmitter and receiver to a different channel to avoid interference.</li> <li>• Make sure the antennas on both the receiver and transmitter are fully extended and not obstructed.</li> <li>• Reduce the distance between the transmitter and receiver.</li> <li>• Ensure there are no obstacles or electronic devices causing interference between the transmitter and receiver.</li> </ul>

# Specifications

## Specification

### • Overall System

Frequency Range	500 MHz - 590 MHz
Frequency Stability	$\leq \pm 30$ ppm
Audio Dynamic Range	> 90 dB
T.H.D	< 0.5%
Frequency Response	40 Hz-15 kHz $\pm 3$ dB
Output Plug	XLR balanced, 1/4" unbalanced plug
Output Voltage	1/4" 0-500 mV
Operating Temperature	-10 °C ~ +50 °C

### • Receiver

Antenna Jack	BNC 50 $\Omega$
Rated Power	4 W
S/N	>95 dB (1 kHz-A)
Mirror Frequency Rejection	>80 dB
RF Sensitivity	> 7 dBu
Power Voltage	DC 13.5 V, power adapter

### • Handheld & Bodypack Transmitter

RF Output Power	$\leq 10$ mW
Modulation Mode	FM
Frequency Adjustment Mode	Automatic frequency adjustment
Maximum Frequency	75 kHz
Battery Life	8 hours

# Technical Support & Warranty Information

## **Our warranty to you:**

Phenyx Technology ("Phenyx") warrants Phenyx products against evident defects in material and workmanship for a period of one year from the date of original purchase for use. This warranty is valid exclusively in the US and applies only to the original owner. If you discover a defect covered by this warranty, Phenyx will repair or replace the product at our sole discretion using new or refurbished components. Performance of repairs or replacements under this warranty is subject to registration of your product at [www.phenyxpro.com](http://www.phenyxpro.com)

## **Product failures not covered by this warranty:**

This warranty covers defects in manufacturing that arise from the correct use of the device. It is limited to defects in materials or workmanship and does not cover electrical or mechanical damage resulting from abuse, misuse, unauthorized modification, lack of reasonable care, extreme heat, cold, damage due to natural forces, or corrosive environments. This warranty does not cover the normal wear and tear on covers, housing, connectors, and accessories.

## **Limits of liability:**

If your Phenyx product fails or does not perform as warranted, your sole recourse shall be to replace or repair it as described above. Phenyx will not be liable to you or anyone else for any damages that result from the failure of this product. These damages include, but are not limited to, the following: lost profits, lost savings, lost data, damage to other equipment, and incidental or consequential damages arising from the use of or inability to use this product. IN NO EVENT PHENYX SHALL BE LIABLE FOR MORE THAN THE AMOUNT OF YOUR PURCHASE PRICE, NOT TO EXCEED THE CURRENT LIST PRICE OF THE PRODUCT.

## **How to obtain service under this warranty:**

If you are receiving a system that is defective or you have any questions regarding operation or warranty cover, please contact us at [support@phenyxpro.com](mailto:support@phenyxpro.com) with any questions or concerns and a Phenyx Pro representative will contact you to provide assistance. You can also reach out to us through Facebook page: [www.facebook.com/phenyxusa/](http://www.facebook.com/phenyxusa/) or our official website: [www.phenyxpro.com](http://www.phenyxpro.com).



**PHENYX PRO**®

**Made in China**

**Manufacturer:** Guangzhou VILAN Technology CO., LTD.

**Address:** No.101 Wanggangdexing Road, Baiyun District, Guangzhou, China

**After-sales Service E-mail:** support@phenyxpro.com ; info@phenyxpro.com

**www.phenyxpro.com**